

RoHS Compliance

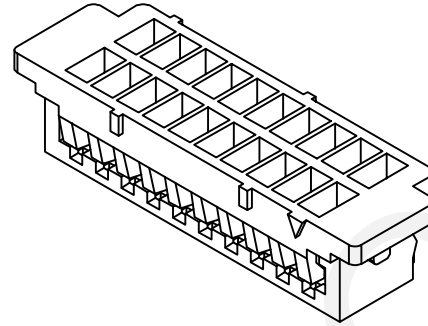
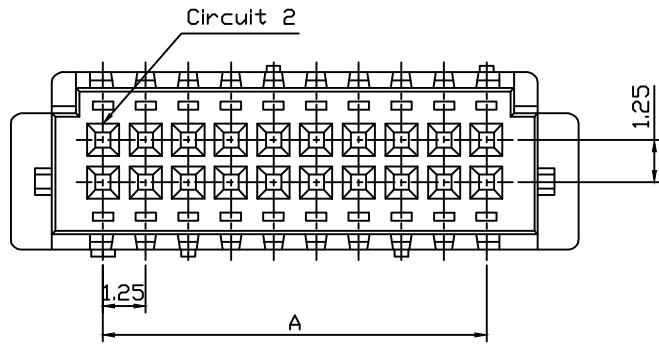

Material:
 Housing: PA66,UL94V-0,Color:Gray
 Electrical Characteristics:
 Current Rating : 1.0A AC,DC
 Voltage Rating : 150V AC,DC
 Temperature Range:-25°C~+85°C
 Insulator Resistance: 500MΩ/Min.
 Withstanding Voltage: 500V AC/Minute
 Contact Resistance: 30MΩ/Max

Order Information:

RHTAYL4-1.25-2-XX-H

Pitch:1.25mm

2-Double Layer

XX-No.of 10~50Pin

Type: _____

H/HA-Hosing T-Terminal

VM-Vertical SMT Pin

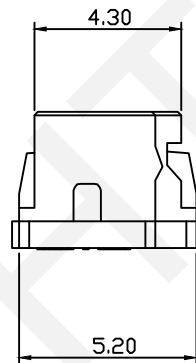
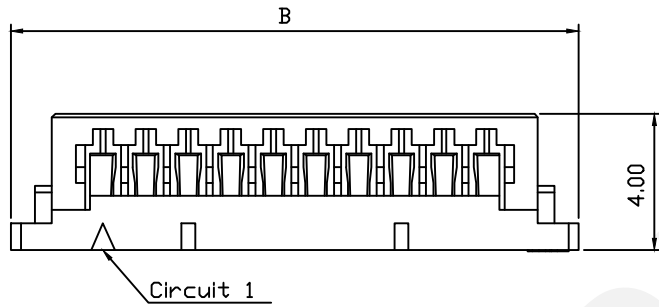

Pin	Dimension mm	
	A	B
2x05	5.00	10.40
2x06	6.25	11.65
2x07	7.50	12.90
2x10	11.25	16.65
2x15	17.50	22.90
2x18	21.25	25.40
2x20	23.75	29.15
2x21	25.00	30.40
2x25	30.00	35.40

RHTECP NINGBO RHT ELECTRONIC CO.,LTD

UNITS:mm	SHEET SIZE: A4	SCALE:---	DRWN BY PAN
0~3	3~18	18~50	50~120
±0.12	±0.15	±0.3	±0.5
			CHK'D BY FENG
			APPR BY ZHAN

1.25mm Pitch DF13 Type
 Wire To Board Connector Double Row

THIRD ANGLE PROJECTION

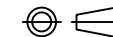

RHTAYL4-1.25-2-XX-H

RoHS Compliance

Material:
 Housing: PA66,UL94V-0,
 Color:White Or Black
 Electrical Characteristics:
 Current Rating : 1.0A AC,DC
 Voltage Rating : 150V AC,DC
 Temperature Range:-25°C~+85°C
 Insulator Resistance: 500MΩ/Min.
 Withstanding Voltage: 500V AC/Minute
 Contact Resistance: 30MΩ/Max

Order Information:
 RHTAYL4-1.25-2-XX-HA

Pitch:1.25mm
 2-Double Layer
 XX-No.of 10~42Pin
 Type: _____

H/HA-Hosing T-Terminal
 VM-Vertical SMT Pin

Pin	Dimension mm		
	A	B	C
2x05	5.00	13.40	15.10
2x06	6.25	14.65	16.35
2x07	7.50	15.90	17.60
2x10	11.25	19.65	21.35
2x15	17.50	25.90	27.60
2x17	20.00	28.40	30.10
2x18	21.25	29.65	31.35
2x20	23.75	32.15	33.85
2x21	25.00	33.40	35.10

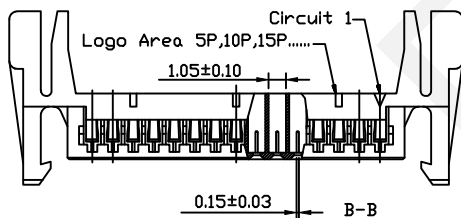
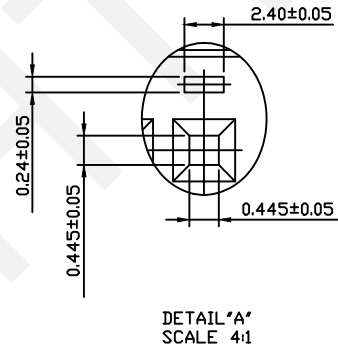
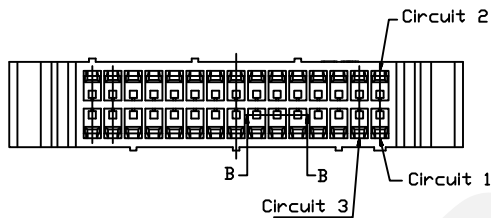
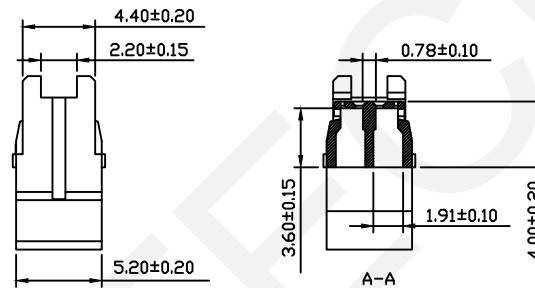
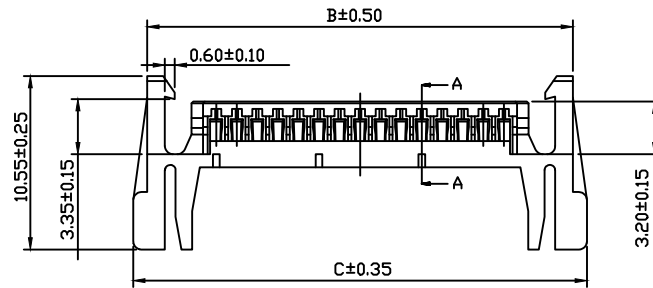
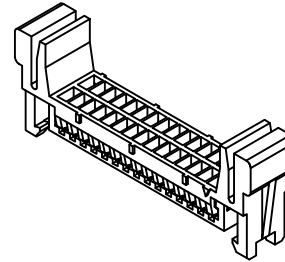
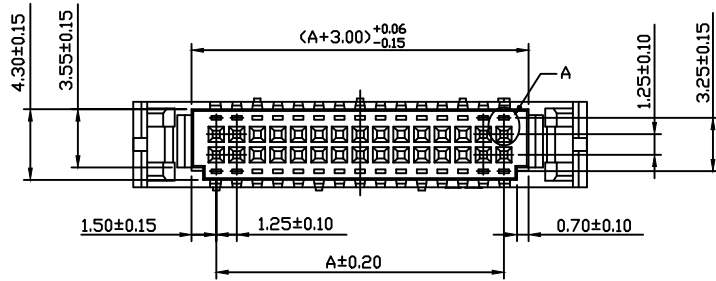

RHTECP NINGBO RHT ELECTRONIC CO.,LTD

UNITS:mm SHEET SIZE: A4 SCALE:---
 0~3 3~18 18~50 50~120
 ±0.12 ±0.15 ±0.3 ±0.5

DRWN BY PAN
 CHK'D BY FENG
 APPR BY ZHAN

1.25mm Pitch DF13 Type
 Wire To Board Connector Double Row
 THIRD ANGLE PROJECTION

 RHTAYL4-1.25-2-XX-HA

RoHS Compliance

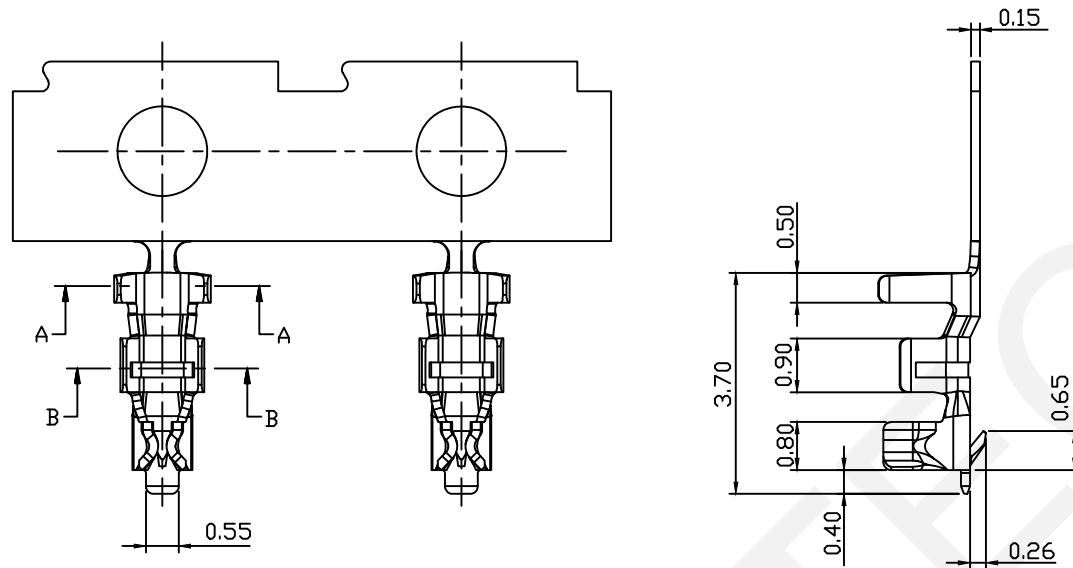

Material:

Terminal: Phosphor Bronze

Plating: Tin plated

Applicable Wires: AWG #26~#30

Insulation \varnothing : 1.00mm Max

Qty/Reel: 20000 Pcs

Electrical Characteristics:

Current Rating : 1.0A AC,DC

Voltage Rating : 150V AC,DC

Temperature Range: -35°C~+85°C

Insulator Resistance: 100M Ω /Min.

Withstanding Voltage: 500V AC/Minute

Contact Resistance: 30M Ω /Max

Order Information:

RHTAYL4-1.25-T

Pitch: 1.25mm

Type:

H-Hosing T-Terminal

S-Straight Male Pin

R-Right Angle Male Pin

VM-Vertical SMT Pin

RM-Horizontal SMT Pin

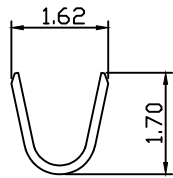

A-A

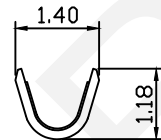

B-B

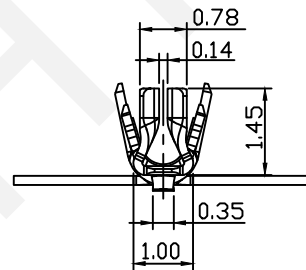

RHTECP NINGBO RHT ELECTRONIC CO.,LTD

UNITS:mm	SHEET SIZE: A4	SCALE:---	DRWN BY PAN
0~3	3~18	18~50	50~120
±0.12	±0.15	±0.3	±0.5

CHK'D BY FENG
APPR BY ZHAN

1.25mm Pitch DF13 Type
Wire To Board Connector Single Row

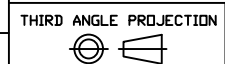

RHTAYL4-1.25-T

RoHS Compliance

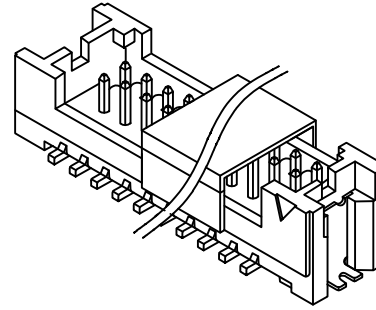
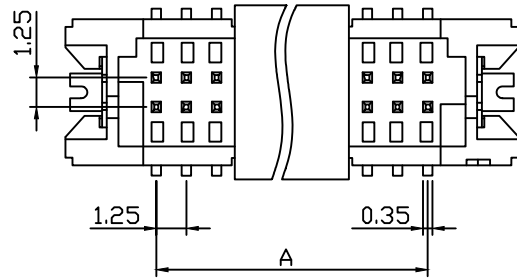

Material:
 Housing: PA9T,UL94V-0,
 Color:Natrual
 Pin:Brass,Gold-flash
 Solder Tabs:Brass,Gold-flash

Electrical Characteristics:

Current Rating : 1.0A AC,DC
 Voltage Rating : 150V AC,DC
 Temperature Range:-25°C~+85°C
 Insulator Resistance: 500MΩ/Min.
 Withstanding Voltage: 500V AC/Minute
 Contact Resistance: 30MΩ/Max

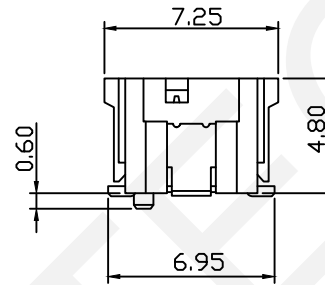
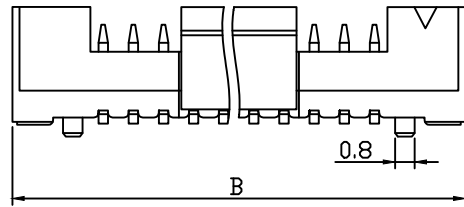

Order Information:

RHTAYL4-1.25-2-XX-VM

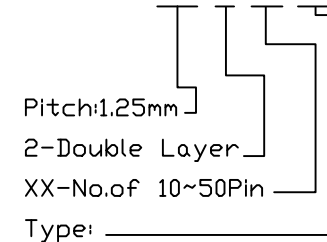

Pitch:1.25mm

2-Double Layer

XX-No.of 10~50Pin

Type:

H/HA-Hosing T-Terminal

VM-Vertical SMT Pin

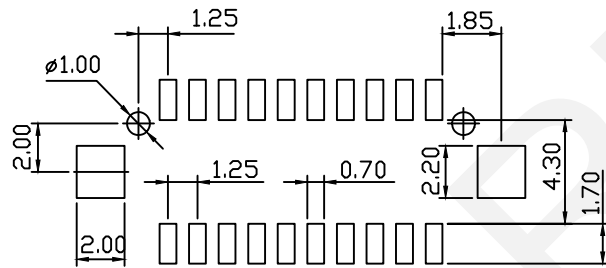

Recommended P.C.B Layout

Pin	Dimension mm	
	A	B
2x05	5.00	12.50
2x06	6.25	13.75
2x07	7.50	15.00
2x10	11.25	18.75
2x12	13.75	21.25
2x15	17.50	25.00
2x20	23.75	31.25
2x25	30.00	37.50

UNITS:mm	SHEET SIZE: A4	SCALE:---	DRWN BY PAN
0~3	3~18	18~50	50~120
±0.12	±0.15	±0.3	±0.5

CHK'D BY FENG
APPR BY ZHAN

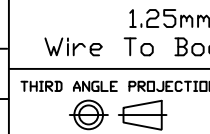

RHTAYL4-1.25-2-XX-VM

RHTECP NINGBO RHT ELECTRONIC CO.,LTD