

RoHS Compliance

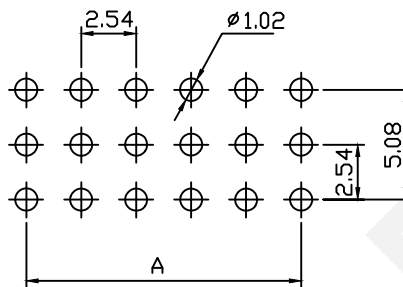

Recommended P.C.B Hole Layout

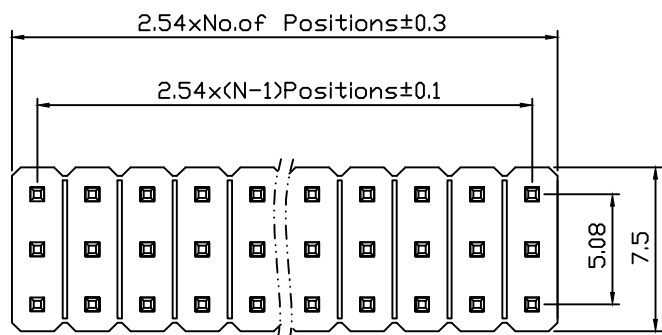
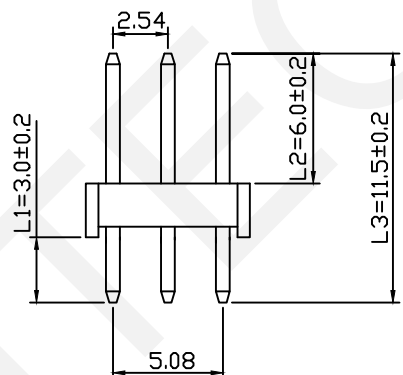
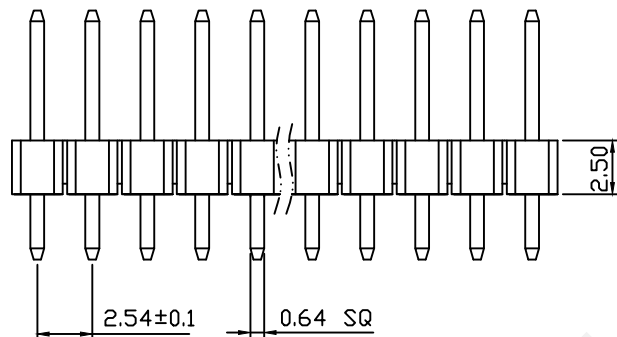

Dimension Antitheses List (mm)				
ITEM	L1	L2	L3	Plastic Height
Standard	3.0	6.0	11.5	2.50
Nonstandard	---	---	---	---

Material:

Standard: PA6T

Contact: Brass

Insulator: Polyester,UL94V-0

Electrical Characteristics:

Rated Current: 3AMP

Contact Resistance: 20mΩ Max

Withstand Voltage: 1000V AC/DC

Insulator Resistance: 1000MΩ Min

Mechanical

Operating Temperature: -40°C~+105°C

Order Information:

RHTAY07-3-XX-S-L1xL2xL3-G0

Pin Header Series

07:2.54mm

Per Row:Three Layer

Pin: No. Of Pins (03~120)

Type: Straight Pin.

Size:L1xL2xL3

Plating:

G0=Gold Flash G1=1u" Gold

G10=10u" Gold G15=15u" Gold

G30=30u" Gold

RHTECP NINGBO RHT ELECTRONIC CO.,LTD

UNITS:mm	SHEET SIZE: A4	SCALE:---	DRWN BY PAN
0~3	3~18	18~50	50~120
±0.12	±0.15	±0.3	±0.5

CHK'D BY FENG
APPR BY ZHAN

2.54x2.5 Pin Header
Three Layer, Straight Pin, 3xN Pin
THIRD ANGLE PROJECTION
RHTAY07-3-XX-S-L1xL2xL3-G0

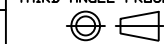

RoHS Compliance

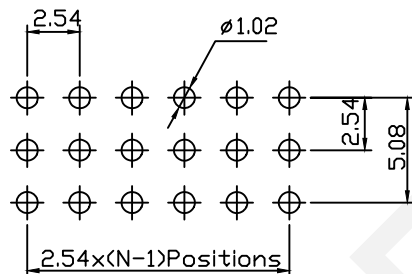
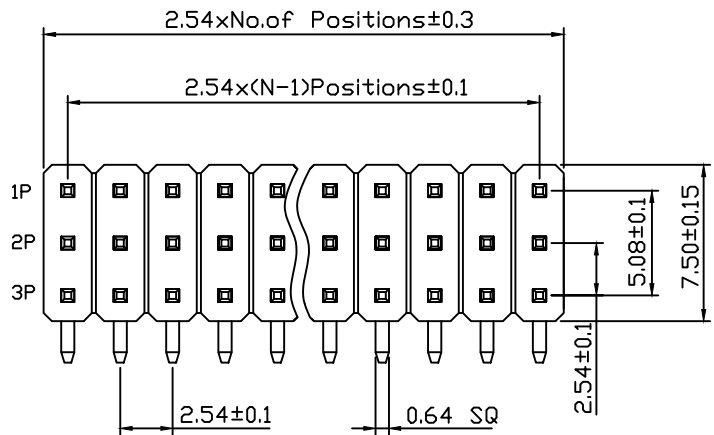

Recommended P.C.B Layout (Top Side)
(PCB BOARD TOLERANCE±0.05)

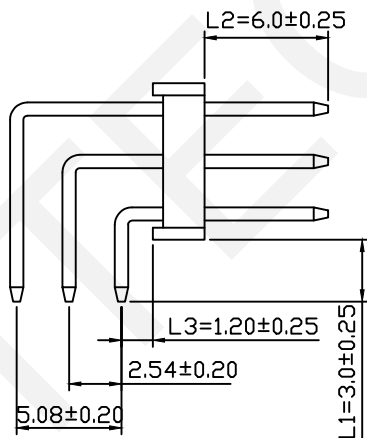
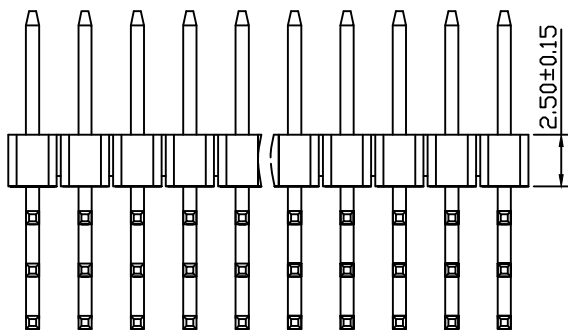

R1 Type

Dimension Antitheses List (mm)				
ITEM	L1	L2	L3	Plastic Height
Standard	3.00	6.00	1.20	2.50
Nonstandard	---	---	---	---

Material:

Standard: PA6T

Contact: Brass

Insulator: Polyester, UL94V-0

Electrical Characteristics:

Rated Current: 3AMP

Contact Resistance: 20mΩ Max

Withstand Voltage: 1000V AC/DC

Insulator Resistance: 1000MΩ Min

Mechanical

Operating Temperature: -40°C~+105°C

Order Information:

RHTAY07-3-XX-R1-L1xL2xL3-G0

Pin Header Series

07:2.54mm

Per Row: Three Layer

Pin: No. Of Pins (03~120)

Right Angle Pin: R1 Type

Size: L1xL2xL3

Plating:

G0=Gold Flash G1=1u" Gold

G10=10u" Gold G15=15u" Gold

G30=30u" Gold

RHTECP NINGBO RHT ELECTRONIC CO.,LTD

UNITS:mm	SHEET SIZE: A4	SCALE:---	DRWN BY PAN
0~3	3~18	18~50	50~120
±0.12	±0.15	±0.3	±0.5
CHK'D BY FENG		APPR BY ZHAN	

2.54x2.5 Pin Header
Three Layer, Right Angle Pin, 3xN Pin
THIRD ANGLE PROJECTION
RHTAY07-3-XX-R1-L1xL2xL3-G0

